

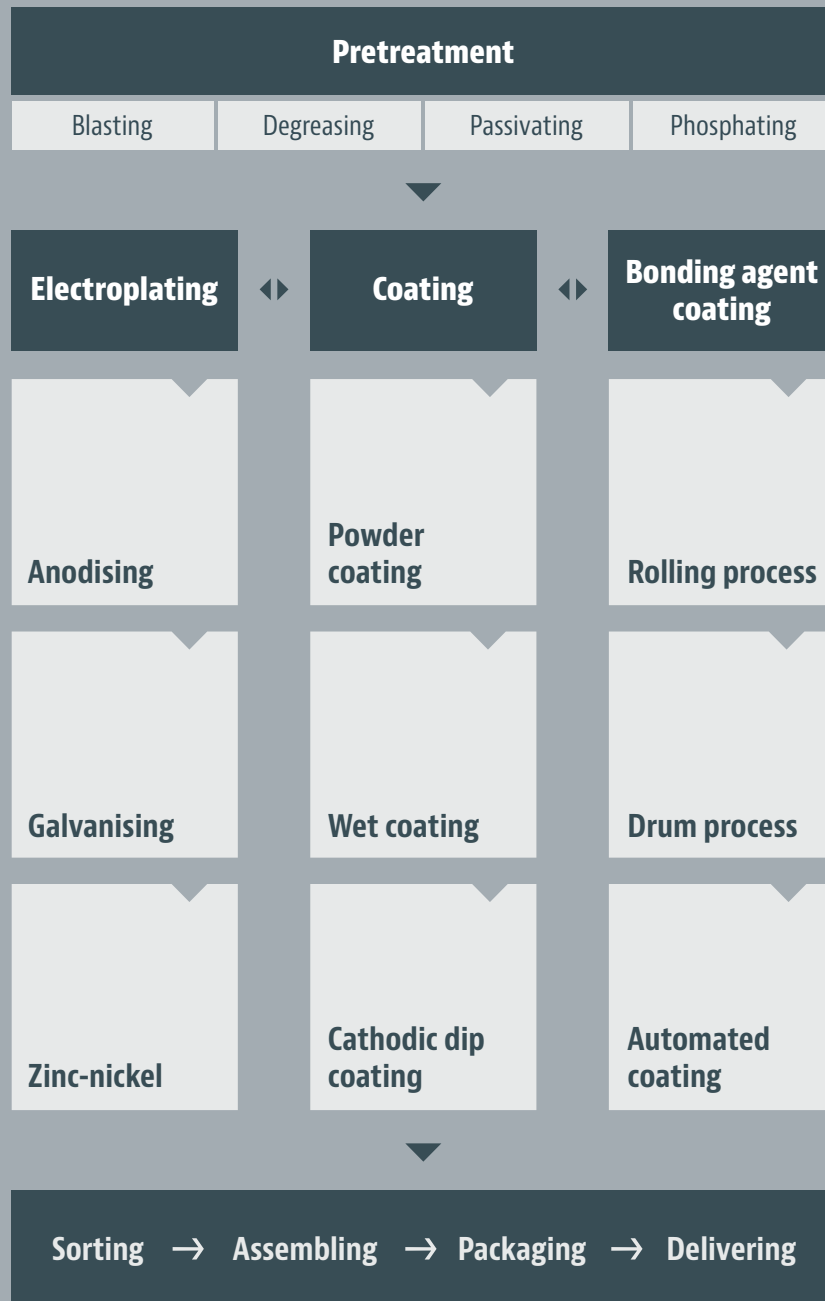

WALTER WERNER
METALLVEREDELUNG

FOR A BETTER
FINISH

OUR SERVICES – FROM ONE SOURCE AT ONE SITE



Our process portfolio yields surfaces that are both functional and decorative and protects e.g. metals and plastics against corrosion and wear. Certified under [IATF 16949](#), [AIAG CQI 11](#), [AIAG CQI 12](#) and registered with [EMAS](#), our company applies environmentally friendly production processes for audited product quality each and every time.





WALTER WERNER
METALLVEREDELUNG

FOR A BETTER
FINISH

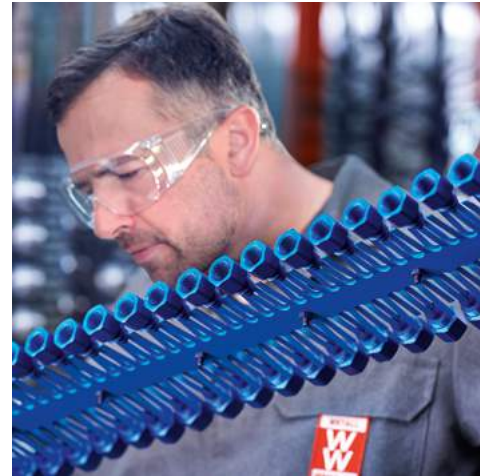
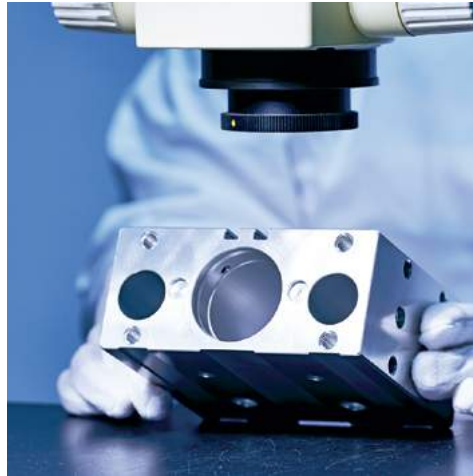

WALTER WERNER FOR A BETTER FINISH – YOUR CERTIFIED SPECIALIST FOR METAL FINISHING

Walter Werner GmbH has been renowned for its professional surface finishing since 1957. Whether for mass production or single pieces, we are the one source of all metal and plastic finishing services based on electroplated, chemical, and organic coatings. The following pages present some details on our processes and combinations. You think we've overlooked a standard, or you want us to make a product to your company's specifications? Then contact us! We'll also be pleased to apply sample coatings to your components.

As far as our logistics is concerned, we know only the one solution: the right part in the right quantity at the right time in the right place. Short routes and high flexibility are our strengths. From our location, we can even provide anywhere in Europe custom logistics services that are far from everyday routine. For instance, Walter Werner also finishes parts from Spain, Italy, France, the Netherlands, Taiwan, India, and China.





OUR SERVICE PORTFOLIO

Surface finishing – far more than just what you see on the surface.

The value of a product can't always be recognised at first glance. Often it is the configuration of its surface that constitutes its actual quality. Coatings must fulfil strict requirements imposed by new materials and applications that are constantly growing in complexity.

Whether the product must be abrasion proof, corrosion resistant, lightfast, and/or conductive, or whether it is to receive a

partial or full surface coating – the appropriate finish guarantees its protection and long service life.

State of the art is safeguarded by permanent investments in our plant and equipment. Both our established innovative processes and our special solutions have been applied to great success in the machine building, mould making, automotive, electrical, and electronics industries.

PRETREATMENT



Blasting

For cleaning parts and roughening metals and plastics.

The selected blasting method and medium depend on the targeted results, the surface configuration, and the quality and utility value of the workpieces.

ESSENTIAL FEATURES

- surface cleaned to specification
- compacted surface
- roughening effect (Rz value)
- wet blasting for decorative surface
- as treatment prior to bonding agent and polymer coating
- partial blasting possible
- variable blasting media, e.g. corundum, glass beads, urea, steel, ceramic, and many more besides

APPLICATIONS

Automotive industry, building and agricultural machinery, machine building

AUDITED QUALITY

DIN, EN, ISO, CONTI, VOESTALPINE, ZF

Passivating

Corrosion protection of light alloys prior to painting.

Passivation generates on the surface a thin conversion coat of defined thickness and resistance. This provides an excellent substrate for downstream processes like welding, bonding, and painting.

ESSENTIAL FEATURES

- cost effective corrosion protection
- keying surface for subsequent
 - bonding agent coating,
 - Cathodic dip coating
 - powder coating, and
 - wet coating
- environmentally friendly process

APPLICATIONS

Automotive industry, building and agricultural machinery, electrical/electronics industry, aerospace, machine building

AUDITED QUALITY

DIN, EN, ISO, FESTO

Phosphating

The ideal treatment prior to corrosion protection and keying.

The wide range of phosphating processes implemented at Walter Werner provides all kinds of pretreatment variants.

ESSENTIAL FEATURES

- temperature resistant
- optimal keying for subsequent coatings enhancing corrosion resistance
- corrosion protection enhanced with oils, waxes, and emulsions
- zinc-phosphate coating with good antifriction properties

APPLICATIONS

Automotive industry, construction industry, building and agricultural machinery, machine building

AUDITED QUALITY

DIN, EN, ISO, BMW GS, BOGE, BOSCH, GMW, LMN, SACHS

ELECTROPLATING



Anodising

Reliable corrosion protection for aluminium.

Constituting the electrolytic oxidation of aluminium, anodising utilises an electro-chemical process to generate a corrosion resistant coating on the surface of aluminium.

ESSENTIAL FEATURES

- resistant to solvents, acids, and weak alkalis
- electrically insulating effects
- weather resistant
- optimal antifriction properties
- colourability for decorative effects
- suitable for Cathodic dip coating and bonding agents

APPLICATIONS

Automotive industry, machine building, also approved for aerospace applications

AUDITED QUALITY

DIN, EN, ISO, BMW, BOSCH, FESTO, LEICA, LN, MIL A, PORSCHE, VW

Galvanising

Cost effective corrosion protection for steel components.

Zinc plated iron parts have visual appeal. We also apply this finishing variant as a cost effective treatment prior to downstream coating processes.

ESSENTIAL FEATURES

- no change to component contours
- visual appeal
- coating built up within tight tolerances
- various passivation processes possible

APPLICATIONS

Automotive industry, construction industry, building and agricultural machinery, electrical/electronics industry

AUDITED QUALITY

DIN, EN, ISO, BEHR, BMW GS, BOSCH, BROSE, DBL, FIAT, GMW, JOHN DEERE, PORSCHE, VDA, VOLVO, VW

Zinc-nickel (alkaline and acid)

Ideal corrosion protection for heavy duty parts.

This zinc-nickel alloy is our solution for components exposed to highly corrosive and severe environmental effects. The coating can be applied by both the alkaline and acid processes.

ESSENTIAL FEATURES

- high temperature resistance
- excellent ductility
- no contact corrosion with aluminium and magnesium
- various passivation processes possible
- suitable for wet coating, Cathodic dip coating, and bonding agents

APPLICATIONS

Automotive industry, construction industry, building and agricultural machinery, electrical/electronics industry, wind power and HVAC installations

AUDITED QUALITY

DIN, EN, ISO, BMW, BOSCH, DBL, FIAT, FORD, GME, GMW, LMN, PSA, VDA, VW

COATING



Powder coating

The solvent free alternative for functional and decorative surfaces.

Powder coatings generally consist of grainy particles whose size and flowability define the function and look of the finished surface.

ESSENTIAL FEATURES

- functional corrosion protection
- chemical resistant
- visual appeal with protective function
- secure grip
- electrically insulating or conductive effects
- particularly environmentally compatible

APPLICATIONS

Automotive industry, building and agricultural machinery, electrical/electronics industry, machine building

AUDITED QUALITY

BOMAG, EVO, JOHN DEERE, LIEBHERR, MAN, VOLVO, VW

Wet coating

Classical coating for functional and decorative surfaces.

Spray processes can apply liquid paints with diverse properties, colours, and textures. These coatings can be applied to the most diverse substrates.

ESSENTIAL FEATURES

- coatings with protective effects
- functional effects provided e.g. by corrosion protection, scratch protection, antifriction or antiadhesive coatings
- decorative look
- electrically insulating or conductive effects
- wide range of combinations

APPLICATIONS

Automotive industry, building and agricultural machinery, electrical/electronics industry, aerospace, machine building

AUDITED QUALITY

DBL, FESTO, HYDAC, JOHN DEERE, LIEBHERR, PORSCHE, VOLVO

Cathodic dip coating

The environmentally friendly coating solution for complex components.

The result is a coating of uniform thickness and optimal surface quality on metal surfaces and in cavities.

ESSENTIAL FEATURES

- resistant to solvents and insensitive to alkalis and acids
- excellent corrosion resistance
- coating thicknesses up to 50 µm possible
- coating also suitable for decorative purposes
- electrically insulating effects

APPLICATIONS

Automotive industry, building and agricultural machinery, electrical/electronics industry, aviation, machine building

AUDITED QUALITY

BMW GS, DBL, EVO, FORD, GMW, PSA, RENAULT, VOLVO, VW

BONDING AGENT COATING

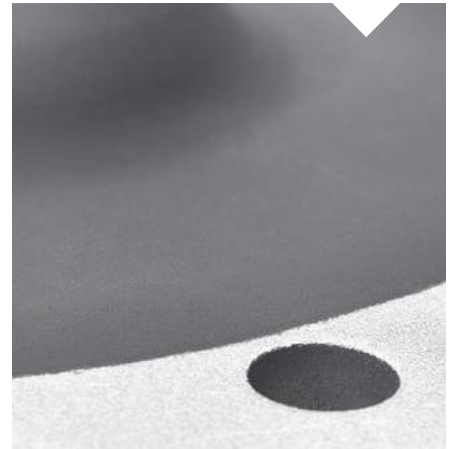

Rolling process

Low material consumption for cost effectiveness.

This process uses rotating rubber rollers to apply the coating substances to one or both sides of the product. Another roller meters the coating substance directly to the application roller.

ESSENTIAL FEATURES

- metal and plastic workpieces possible
- all conventional bonding agent systems possible
- wide range of pretreatment combinations
- combinations with optional corrosion protection + bonding agent from one source

APPLICATIONS

Automotive industry, machine building, vibration engineering

AUDITED QUALITY

BMW, CONTI, FESTO, LMN, TRELLEBORG, VIBRACOUSTIC, VW, ZF

Drum process

Coating and drying in one process step.

A specially configured nozzle system sprays the bonding agent uniformly over the rotating small parts without bonding them to each other. A set temperature then cures the components directly in the drum.

ESSENTIAL FEATURES

- metal and plastic workpieces possible
- all bonding agent systems recommended for drum processes possible
- wide range of pretreatment combinations
- combinations with optional degreasing + phosphate + bonding agent from one source

APPLICATIONS

Automotive industry, machine building, vibration engineering

AUDITED QUALITY

BMW, CONTI, FESTO, LMN, TRELLEBORG, VIBRACOUSTIC, VW, ZF

Automated coating

Bonding agent coating for medium and high volume variants.

In chain type and round table coating machines, the components are sprayed continuously from a configured nozzle system and afterwards dried directly. Large piece numbers and short throughput times are possible.

ESSENTIAL FEATURES

- metal and plastic workpieces possible
- all conventional bonding agent systems possible
- wide range of pretreatment combinations
- combinations with optional corrosion protection + bonding agent from one source

APPLICATIONS

Automotive industry, machine building, vibration engineering

AUDITED QUALITY

BMW, CONTI, FESTO, LMN, TRELLEBORG, VIBRACOUSTIC, VW, ZF

COMBINATIONS AND SPECIAL SOLUTIONS



OPTIMALLY COMBINED AND FROM ONE SOURCE – A TYPICAL SECTION THROUGH THE INDUSTRY

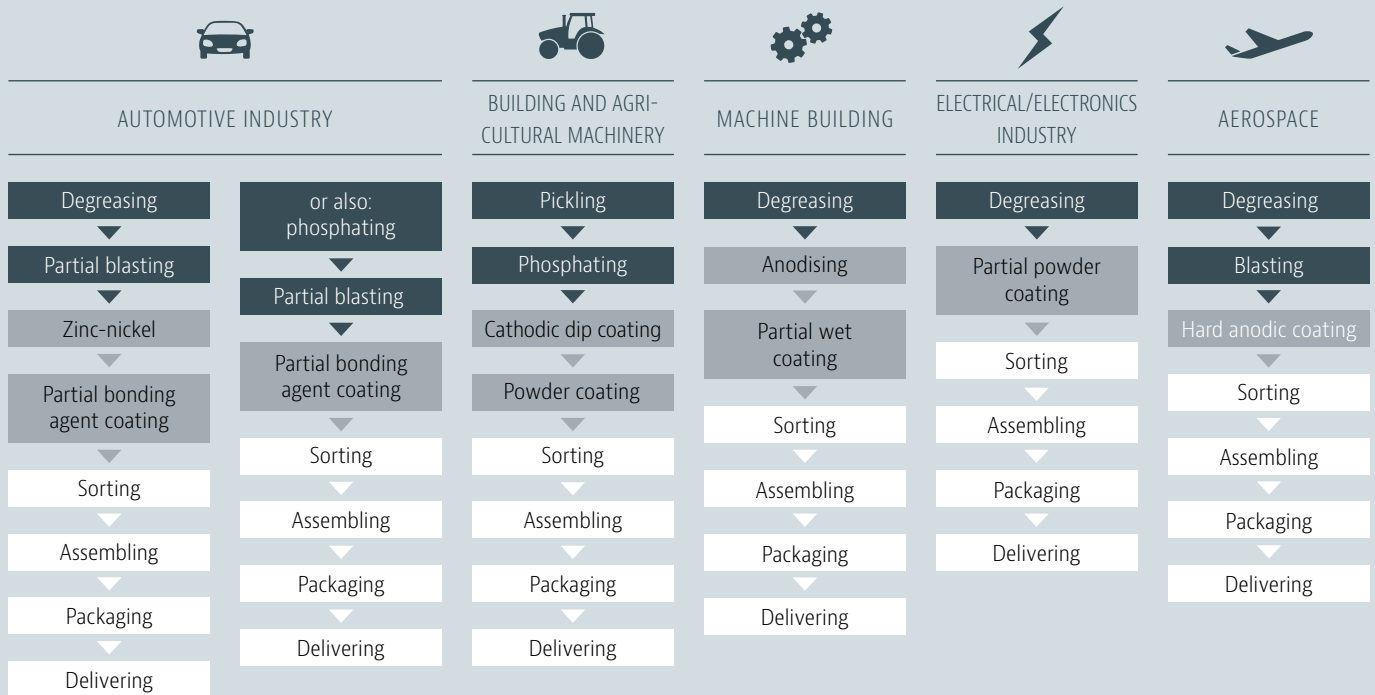

SPECIAL SOLUTIONS – UTILISE OUR EXPERIENCE FOR YOUR NEEDS.

We understand service quality to include special custom solutions, e.g. for teflon and nano coating applications. Do you have a specific challenge? Then contact us! We'll be pleased to advise you and apply sample coatings to your products.



Quality is when the customer comes back. Not the product.

Citation source: Dr Günther Schreiber, Sector Manager for Healthcare Systems at Quality Austria GmbH

We don't leave quality to chance. As a medium sized family run enterprise, we attach just as much importance to responsible and sustainable action as we do to product quality. And this not only for the benefit of the people working for us, but also for our environment – ever since Walter Werner personally founded our company.

Quality and environmental awareness – the company's mainstays since 1957.

In 2000, we were one of the first companies in this sector to register with EMAS, the highest environmental standard for producing companies. In cooperation with Birkenfeld Environmental Campus,

we contribute to the preservation of natural resources by investing in pioneering technologies. For example, in our own, ultra modern waste water treatment plant. Or in a thermal oxidiser, of which only very few are operating so far in the world.

Proven quality is good.

Regular control is better.

Computer controlled processes monitor and document the operations and chemical parameters of each system. Our inhouse, independent laboratory conducts all of the standard test procedures needed to maintain our high level of surface quality.

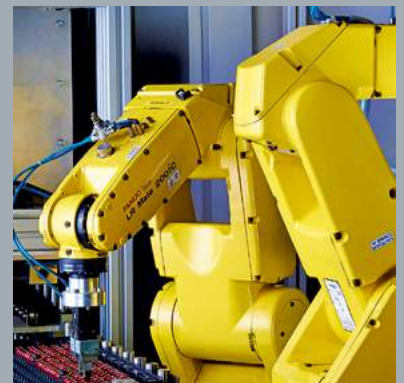

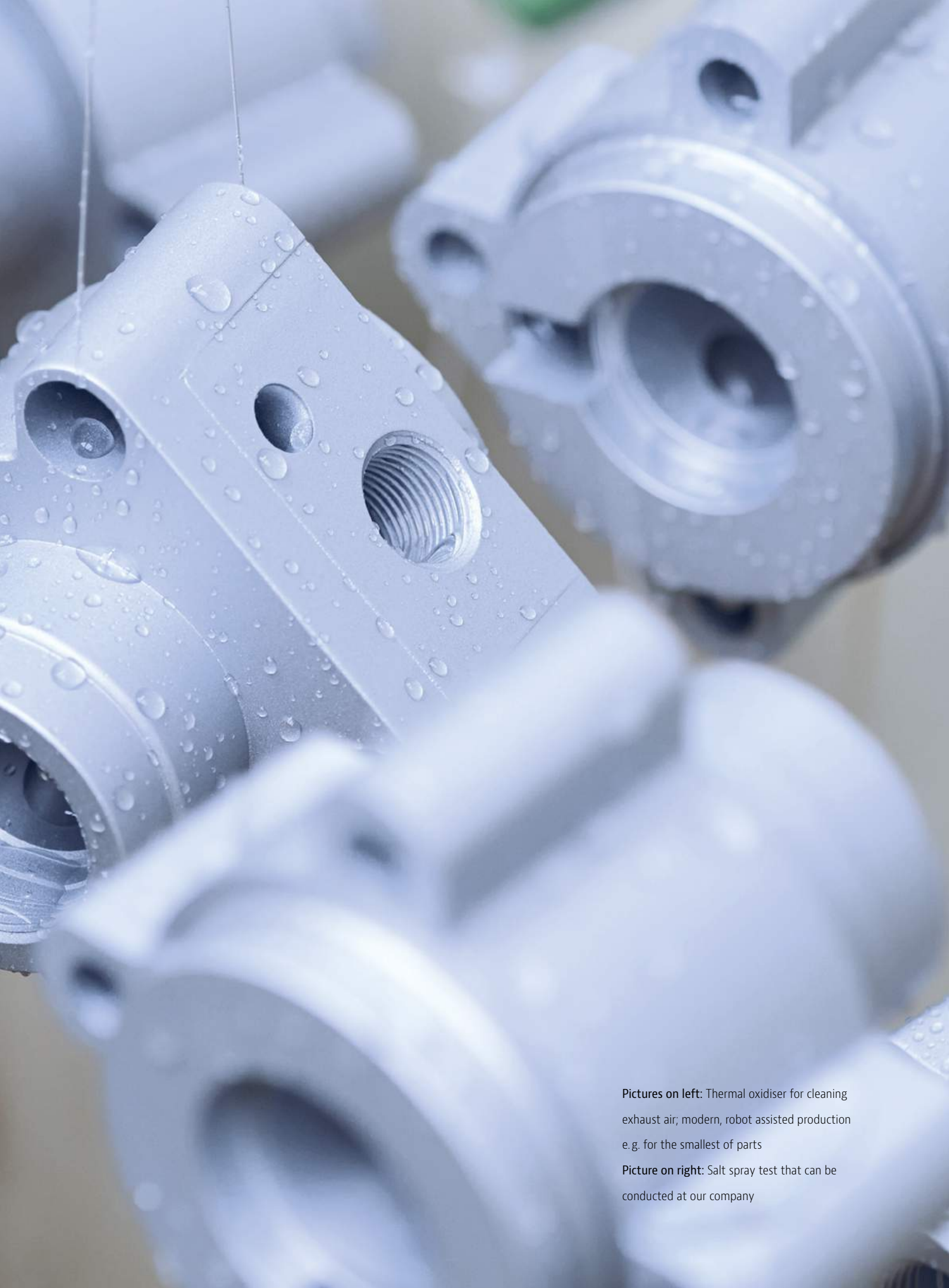

Pictures on left: Thermal oxidiser for cleaning exhaust air; modern, robot assisted production e.g. for the smallest of parts

Picture on right: Salt spray test that can be conducted at our company

WALTER WERNER PREMISES

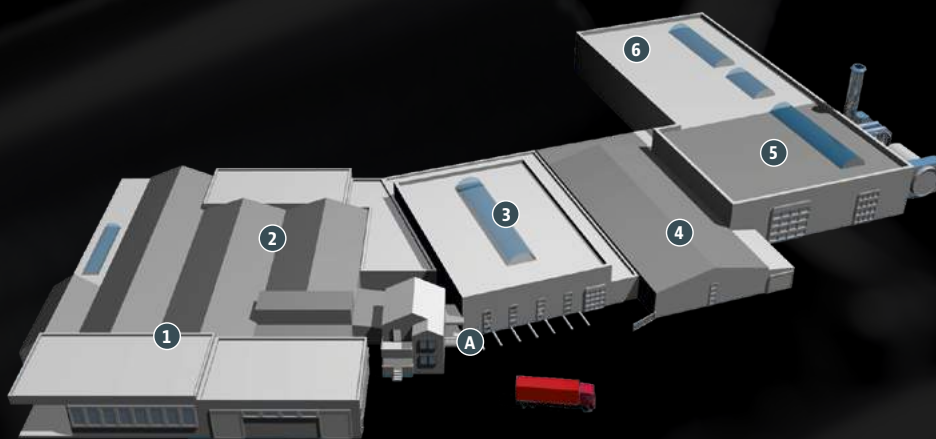

- A Reception/entrance
- 1 Coating
- 2 Electroplating
- 3 Incoming goods, stores
- 4 Pretreatment
- 5 Bonding agent coating
- 6 Shipping

Walter Werner GmbH · Metallveredelung · Dambacher Weg 2 · 55765 Birkenfeld/Nahe

Phone: +49 6782 9932-0 · Fax: +49 6782 9932-30 · E-Mail: info@walter-werner.de · www.walter-werner.de